

OCN-26D

Pitch (terminal to terminal) : 5.6 mm

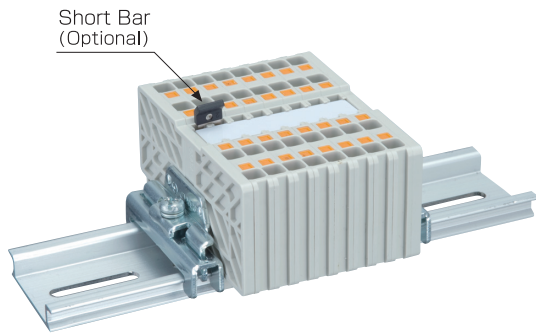

※Another sales (Din-rail and Stopper)

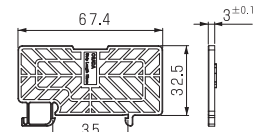
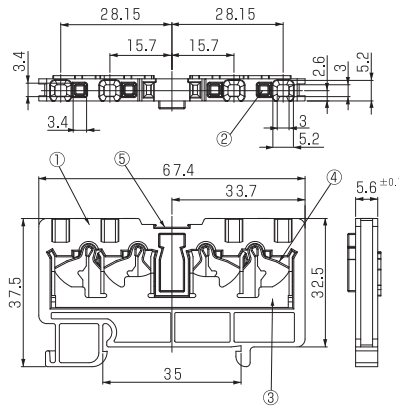

Side Plate **OCN-26D-A**

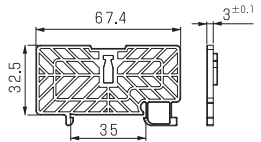

Side Plate **OCN-26D-B**

Specifications

Electrical Rating	Sol 600V, 20A Str 600V, 15A
Insulation Resistance	DC500V, 1000MΩ
Withstanding Voltage	AC2500V
Cable Range	Sol AWG24~10 Str AWG26~12
Wire Strip Length	13mm
Stick Terminal	10~12mm
Storage Temperature Rating	-40°C~+65°C
Usage Temperature Rating	-40°C~+65°C

Composition

No.	Part Name	Materials	Flame Class	Treatment	Remarks
①	Base	PA 66	94V-0		Gray
②	Push Button	PBT	94V-0		Orange
③	Terminal	Brass		Sn	
④	Spring	SUS301			
⑤	Marking Strip	PET			Optional

Ordering Lot

Part Name	Base	Side Plate (Unit)	
Order Name	OCN-26D	OCN-26D-A	OCN-26D-B
Piece	50	5	5